

Band Saw Blades for Wood Cutting Gang Saw Blades



Dimensions:

Dimensions of band saw blade depend on the machine type and material type.

Width of the band saw blade type 22 5340 – C75 or 22 5340 – UDD is determined by the smallest radius that is cut in the material. Otherwise the width may be by max.10 mm wider than width of common discs of the particular machine.

Minimum radius [mm]	25	50	100	150	200	300	400	500	600	700
Width of blade [mm]	6	10	15	20	25	30	35	40	45	50

Band saw blades type 22 5340 – WM1, 22 5340 – WM2 or 22 5340 – WM3 the width of blade is determined by machine builder and it is calculated from common coils. Thickness of band saw blade must not exceed value S1 because material of band saw blade would be too strained while bending and mechanical damage could happen.

S1=diameter of welded coil [mm] 1000

When choosing the right tooth pitch, the height of cutting material must be considered. We recommend 3 – 5 teeth to be in cut.

Working conditions: Maximum cutting speed of band saw blade is recommended by the machine builder. Usually the speed is between 20 – 35 m/sec. General rule is that the harder cutting material, the lower cutting speed we use.

General rules for usage:

1. Before you start cutting check if the band saw blade is properly sharpened, set and whether it is not damaged or heated up. Band saw heating can be recognized if blade is purple color even after cooling.
2. Band saw blade must be properly straightened. Please be aware not to straighten the blade too much. This could cause disruption of the blade.

Maximum recommended values of straightening the band saw blade.

Type: 22 5340 C75, 22 5340 UDD

Dimensions H x S x T [mm]	Tensile stress [Mpa]	Tensioning strength [N]
6 x 0,5 x 4	25	105
8 x 0,5 x 5	25	142,5
10 x 0,6 x 6	25	211,5
12 x 0,6 x 7	30	320
15 x 0,6 x 7	30	428
16 x 0,6 x 7	30	464
20 x 0,6 x 8	30	585
25 x 0,6 x 8	30	893
25 x 0,7 x 8	30	1006
30 x 0,7 x 10	30	1245
35 x 0,8 x 10	40	1702
40 x 0,7 x 10	45	2190
40 x 0,8 x 10	45	2550
45 x 0,9 x 12	50	3564
50 x 0,9 x 12	50	4014

Type: 22 5340 WM1, 22 5340 WM2, 22 5340 WM3

Dimensions H x S x T [mm]	Tensile stress [Mpa]	Tensioning strength [N]
32 x 0,9 x 22	40	1840
32 x 1,0 x 22	40	2040
32 x 1,1 x 22	40	2240
35 x 0,9 x 22	40	2050
35 x 1,0 x 22	40	2280
35 x 1,1 x 22	40	2510
40 x 0,9 x 22	45	2700
40 x 1,1 x 22	40	2930
50 x 1,1 x 22	50	4760

3. Guidance of blade and guiding wheels must be clean from chips and resin. Allowance between guiding and band saw blade may be maximum 0,2mm. The distance between the top guidance from the cutting material should be as little as possible so that blade rigidity is as big as possible.
4. Hold the cutting material with both hands so that your body is not in the same level as the cutting blade. Do not cut material using extra strength.
5. Start cutting after the proper cutting speed is achieved. Do not shorten or slow down the cutting period by friction of the blade against the side of material or slowing against cutting material.
6. While cutting big dimensions it is important to use fixed guidance. While finish sizing the material it is important to use holding device.
7. It is necessary to replace the band saw blade and set it away (even if not dull). Mechanical attributes of band saw blade will remain the same.
8. Do not let the band saw to heat up by any means. If this happens, set away the blade immediately and after cooling set and sharpen it again. You can also check the straightness. To prevent heating it is better to sharpen the blades in time and follow the right cutting conditions.
9. Replace the band saw blade if any break off occurs.
10. After finishing cutting process do not leave the band saw blade straightened in the machine, always loosen it.

Service:

Tooth setting is done to 1/2 to 2/3 tooth height and is set by 1/2 to 1/3 over the size of band saw thickness. Tooth setting can be even bigger for soft woods but there must never happen that a piece of wood remains in between the teeth. Please keep the same distance while tooth setting the whole band saw blade. Pay special attention to regularity of setting (max. 0,1 mm). If not, run in of blade might occur on the side where the bigger tooth set is.

Tooth sharpening is done ceramic disc with medium grain roughness. Tooth face is sharpened. If the blade is extra dull, it is possible to sharpen the tooth back as well. Prevent the tooth to become black from annealing (unwanted stage). While grinding it is needed to keep the radius on tooth bottom. Sharp edge on tooth bottom could cause blade breakage.

Recommendations How to Use Band Saw Blades

The most common causes of trouble while cutting with band saw blades is wrong choice of band saw blade type, dimensions of blade or wrong tooth pitch for particular material. The second most common problem is wrong performance of cutting conditions and usage of insufficiently set or dull band saw blade.

In the below tab you can find most common problems and their possible solution.

Most common problem	Probable reason	Solution
Broken/ fissured blade	• Wrong tooth pitch	Choose a blade with tooth pitch so that 3-5 teeth are in cut
	• Overstressing of blade	Lower the blade straightness between circling wheels
	• Feed is too high	Lower down-force of material on the blade
	• Teeth are in contact with material before cutting	Adjust allowance between blade/material to minimum 10mm before cutting
	• Diameter of guiding wheels is too small	Use a thinner blade
	• Side press on band saw	Adjust manually
Undercutting	• Blade friction against carrier wheels	Adjust parallelity of wheels
	• High feed	Lower the feed speed
	• Insufficient blade straightness	Straighten the blade
	• Damaged top tooth line	Use a blade with harder teeth (hardened)
	• Big allowance between guiding wheels and blade	Lower the guiding wheels
Rough cut	• Big distance between guidance and material	Adjust distance from guidance
	• High feed	Adjust cutting conditions
Blunting of blade	• Wrong tooth pitch	Use correct tooth pitch
	• Cutting with tooth backs	Turn over the band saw blade
Tooth breaking off	• High cutting speed	Lower the cutting speed
	• High pressure on blade	Lower the feed speed
	• Wrong choice of tooth pitch	Use correct tooth pitch
	• Cutting with tooth backs	Turn over the band saw blade
Twisting of blade	• Dirt in cutting material	Do not cut in places where dirt occurs (stones, metals etc.)
	• Blade stuck in cut	Lower the feed speed
	• Free guiding of blade	Adjust the blade guiding

Safety rules for band saw blade usage

Application:

Band saw blades are used for splitting, cutting off wood logs, woodbase materials and light metal alloys. Band saw blades can be used for mechanical or manual feed speed while following the recommended safety rules.

Unwrapping/packing:

When unwrapping/packing and during manipulation (i.e. when setting up into the machine) please proceed with maximum caution! Danger of getting hurt by very sharp objects!

Transport:

Move the tools in an appropriate packing! Danger of getting hurt!

Application:

Nepřekračovat maximální napínací sílu! Pečlivě čistěte oblast napínacích kol a vodítek.

Tool:

Check the cutting edge. Check the machine set up.

Machine:

It is necessary to stop the machine while tool replacement.

Tool set up:

Set up the tool into the machine and secure it following the manufacturer's specification. Follow the manufacturer's safety rules.

Service:

Follow the valid safety rules.

Right function and safety will be preserved only if service is provided according to valid specification of PILANA TOOLS.

How to service the tool:

- Follow the valid regulations
- Unskilled usage and usage out of purpose is forbidden.
- If not required by national law, use specific objects to protect your eyes, ears and mouth.
- Never leave the machine unattended without monitoring!
- Please clean the band saw blades in time and remove resin. Clean blades have longer life-time and are therefore more economical.

Sharpening/servicing:

Well-timed sharpening and cleaning the blade are basic conditions how to keep the quality and follow the safety rules. It is important to have these activities done by an expert.

Tools are often covered by resin and dust etc. Any dirt negatively influences the cutting performance. To clean the machine use only convenient objects, which do not cause rust or chemical damage to band saw blades.

Material: natural wood
Application: joinery, carpentry
Machine: joining band saw machines

40-C 75

Characteristics:

- » it is possible to deliver band saw blades toothed, set, sharpened, hardened
- » band saws are delivered in coils of 25 m or welded to a particular machine length
- » material type is carbon steel C 75 – material hardness 38 – 44 HRC

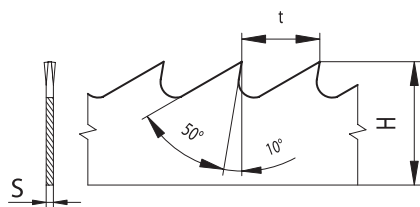
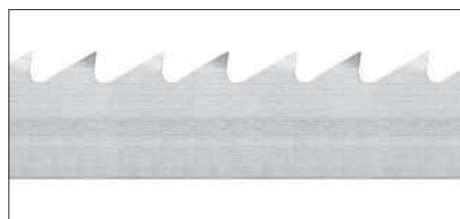
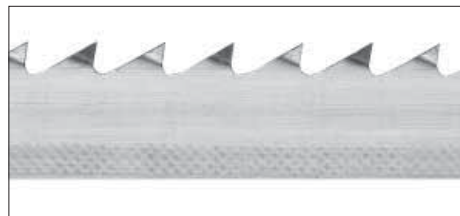

H x S x t [mm]	C 75 set	C 75 set and sharpened	C 75 set, sharpened and hardened
6x0,5x4	●	●	●
8x0,5x5	●	●	●
10x0,6x6	●	●	●
12x0,6x7	●	●	●
15x0,6x7	●	●	●
20x0,6x8	●	●	●
25x0,6x8	●	●	●
25x0,7x8	●	●	●
30x0,7x10	●	●	●
35x0,7x10	●	●	●
40x0,7x10	●	●	●
45x0,9x12	●	●	●
50x0,9x12	●	●	●

40-UDD

Characteristics:

- » it is possible to deliver band saw blades toothed, set, sharpened, hardened
- » band saws are delivered in coils of 25 m or welded to a particular machine length
- » material type is carbon steel C 75 – material hardness 38 – 44 HRC

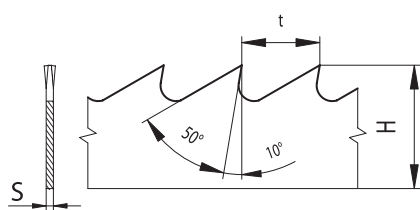
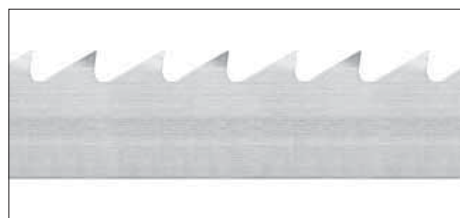
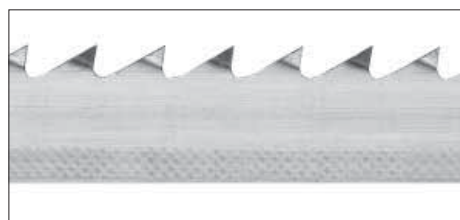

H x S x t [mm]	UDD set	UDD set and sharpened
10x0,6x6	●	●
16x0,6x7	●	●
20x0,6x8	●	●
25x0,7x8	●	●
30x0,7x10	●	●
35x0,8x10	●	●
40x0,8x10	●	●

Material: natural wood
Application: cutting massive natural wood
Machine: mobile band saw machines

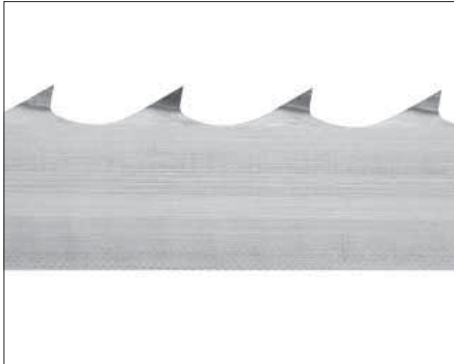

40 WM

Characteristics:

- » We supply band saw blades welded to requested length or in packages (coils) of 25, 50 or 100 m
- » band saw blades are manufactured/welded to the requested length (also sharpened if needed) or packed by 25 m/coil
- » band saw blades type WM1 are for cutting soft woods
- » band saw blades type WM2 are for cutting hard woods
- » band saw blades type WM4 are for cutting very hard woods

WM 1

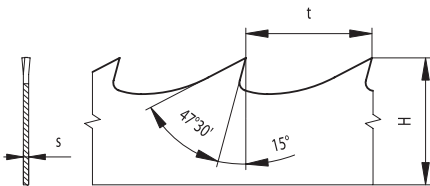

WM 2

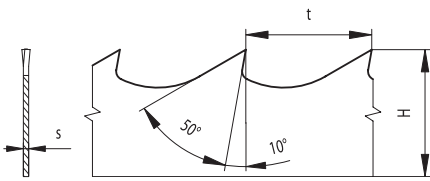

WM 4

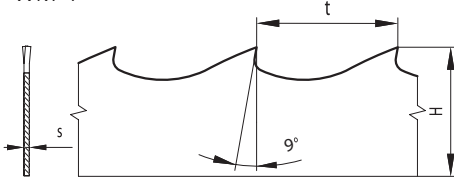

H x S	t	type	toothed	toothed, set	toothed, set, hardened	toothed, set, sharpened	toothed, set, sharpened, hardened
32 x 0,9	22	WM 1	●	●	●	●	●
32 x 1,0			●	●	●	●	●
32 x 1,1			●	●	●	●	●
35 x 0,9			●	●	●	●	●
35 x 1,0			●	●	●	●	●
35 x 1,1			●	●	●	●	●
40 x 0,9	22	WM 2	●	●	●	●	●
40 x 1,0			●	●	●	●	●
40 x 1,1			●	●	●	●	●
50 x 1,1			●	●	●	●	●
32 x 0,9	22,2	WM 4	●	●	●	●	●
32 x 1,0			●	●	●	●	●
32 x 1,1			●	●	●	●	●
35 x 0,9			●	●	●	●	●
35 x 1,0			●	●	●	●	●
35 x 1,1			●	●	●	●	●
40 x 0,9			●	●	●	●	●
40 x 1,0			●	●	●	●	●
40 x 1,1			●	●	●	●	●
50 x 1,1			●	●	●	●	●

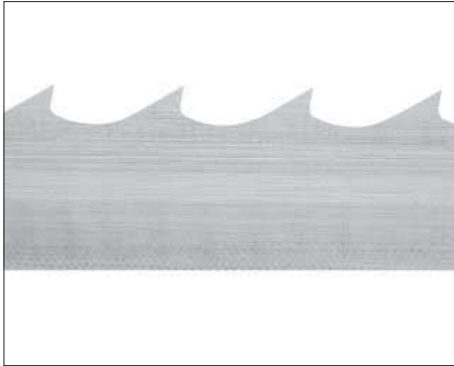

40 Bimetal

Characteristics:

» The Bimetal type band saw blades are designed for cutting very hard wood

H x S	t	Type	set, sharpened, hardened
35 x 0,9	22,2	Bimetal	●

Bimetal

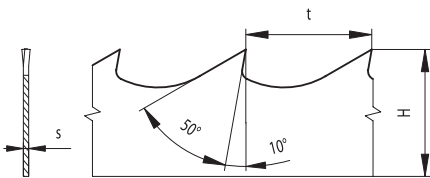

80 – Scoring Saw Blades for Band Saws

Scoring saw blades remove the contaminated bark from the logs in the cutting place. Therefore, the saw band remains sharp for a prolonged period of time and its lifespan increases.

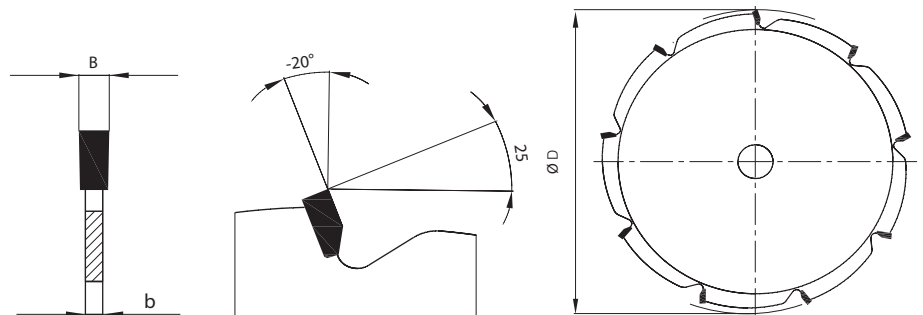



Type BPP 120

The grinder is designed for sharpening of band saw blades with a width of 18–50 mm in a semi-automatic mode. A change in the tooth shape is performed by setting the cams and rods, namely, very simply and quickly. The grinder has two electromotors. One drives the grinding disc and the other ensures band saw blade travel. The band travel speed can be set continuously. The grinder is equipped with cooling of the grinding disc. The grinder is designed for grinding of regularly used tooth shapes; however, a modification for any tooth shape is possible.

Basic Technical Data:

» Width of sharpened band saw blades	18–50 mm
» Length of sharpened band saw blades	2000–5000 mm
» Height of sharpened teeth	3–8 mm
» Tooth pitch	4–30 mm
» Band travel speed – continuously adjustable	0–37 teeth/min
» Grinding disc travel motor input	120 W
» Band saw blade travel motor input	40 W
» Pump performance	240 l/hr
» Grinding disc dimensions	175 x 6(5) x 20 mm
» Grinder dimensions	320 x 320 x 1300 mm
» Grinder weight	35 kg



Wide Band Saw Blades for Wood – from 80 mm Width



Material: natural wood
Application: cutting massive natural wood
Machine: wide band saw machines

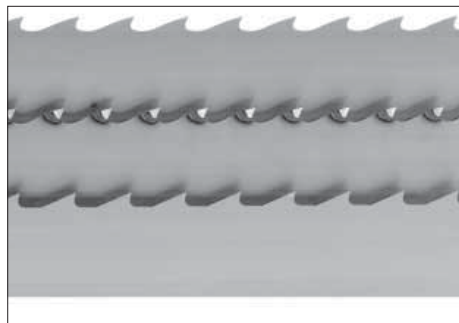

- 5343 (NV) – Triangular Type of Teeth**
- 5344 (KV) – Wolf Type of Teeth**
- 5345 (PV) – Round Type of Teeth**
- 5345-PVI (PVI) – Curved Tothing PVI**

Application: Soft and hard woods. For hard wood it is necessary to choose smaller tooth pitch and for soft wood bigger tooth pitch.

Wide band saw blades are manufactured from material 80NiCr11 or from Uddeholm with hardness 43 ± 2 HRC. The welded blade coils are provided in stellite-tipped, swaged or set versions. A standard treatment is weld straightening and blade mill-rolling. Band saw blades delivered in coils are always provided toothed.

Standard dimensions of wide band saw blades

Width [mm]	Thickness [mm]	Weight (kg/1m)
80	1,0	0,65
90	1,0	0,70
100	1,1	0,80
120	1,1	1,04
140	1,2	1,23
160	1,4	1,66
180	1,4	2,00
200	1,4	2,20
210	1,4	2,35
235	1,6	3,00
265	1,6	3,39

Standard tooth heights for certain tooth pitches and types.

Tooth pitch	Tooth depth [mm]		
	225343 – NV	225344 – KV	225345 – PV
20	9	–	7,5
25	11,5	–	9,0
30	13,5	10	10,5
35	16	11	12,0
40	18	12	11
45	21	13	12,0
50	23,5	14	13

If stellite-tipping it is needed to request the right tooth sharpening (soft or hard woods).



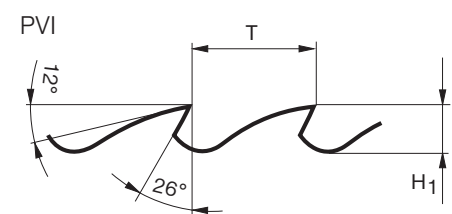
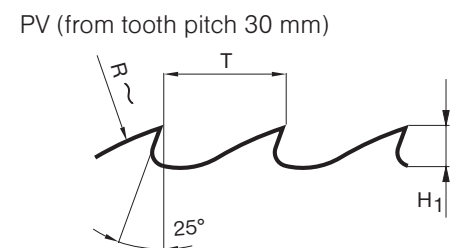
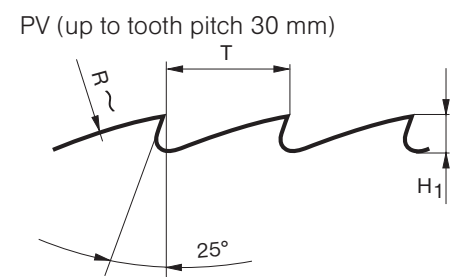
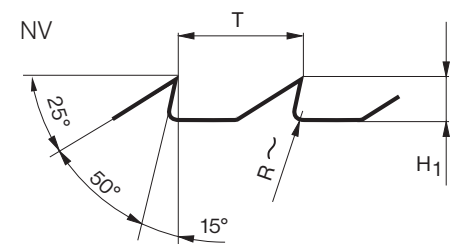
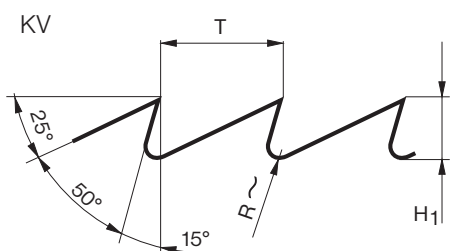

When welding wide band saws the total length must be dividable by chosen tooth pitch. When milling the wide band saws it is needed to specify the type of milling or type of the machine for future usage.



- » maximum cutting speed of each individual band saw blade is specified by the band saw manufacturer
- » the harder is the material which you cut, the lower cutting speed shall be used
- » when cutting soft wood types, it is recommended to use larger tooth pitch; when cutting hard wood types, it is recommended to use smaller tooth pitch
- » before you start cutting, check that the band saw blade is properly sharpened, set and whether it is not damaged or heated up (such heating-up is characterised by purple colour which remains even when it has cooled down)
- » before you use a new band saw blade for the first time, it is necessary to let it "run in" (operate it for 20 minutes with no work load) – then it must "rest" for 24 hours
- » if a heat-up of band saw blade occurs during cutting operation, it is necessary to put it out of operation, leave it to cool down and then re-sharpen it and check its flatness
- » heat-up is best prevented by timely sharpening of blades and by compliance with specified cutting conditions
- » it is necessary to regularly replace the band saw blades even if the toothing is not dull – thus they keep their mechanical characteristics for a prolonged period of time
- » band saw blades must be adequately and evenly tensioned in the machine (however, not excessively, otherwise they may break – comply with the machine manufacturer's specifications)
- » the blade must be always operating in full rotating speed when cut-

- ting – be particularly careful to comply with this instruction in the beginning and in the end of cutting procedure. In case that cracks occur on the blade, discard it
- » in case that cracks occur on the blade, do not continue cutting
- » when you finish work, never leave the saw blade tensioned in the machine, always loosen it
- » band saw blades are tools particularly sensitive to a good quality grinding of its teeth. It is necessary to use a grinding disc with medium-fine grains, do not overheat the blade material, wet-grind with surface roughness of $Ra < 3.2$
- » all angles must be measured with a sextant. Do not rely on the grinder setting.
- » cracks between the teeth occur in grooves made by the grinding disc
- » band saw blades and wheels of the machine must be constantly oiled during the cutting operation. Material chips must never get between the band and wheel
- » there must be no free play in the wheel bearings and the maximum run-out must not exceed 0.03 mm for radial value and 0.1 mm for axial value
- » The blade tensioning system must be maintained in a flawless condition so that it allows thermal expansion of the blade (the band saw blade length under load increases by 1 mm when heated up by 15°C)
- » wheel profile shall maintain the recommended parameters – if excessive wear and tear is apparent, expert servicing is necessary

Values for correct choice of band saw blades

Wood Type				
	hard, frozen, high density	hard, not frozen, medium density	hard, soft, low density	soft, low density
Recommended hook angle (γ)	15°	20°	25°	30°
Tooth pitch (T)	20–25 mm	25–30 mm	30–35 mm	≥ 35 mm
Recommended feed speed	<8 m/min	8–27 m/min	27–46 m/min	>50 m/min
Recommended tooth side dressing	1/3 of the band saw blade thickness	1/3 of the band saw blade thickness	1/3 to 1/2 of the band saw blade thickness	1/2 of the band saw blade thickness

Key:

T – tooth pitch (width of the gaps between teeth); H1 – depth of the gap between teeth;

A – total volume of the gap between teeth, γ – hook angle; β – tooth blade angle; α – tooth back angle

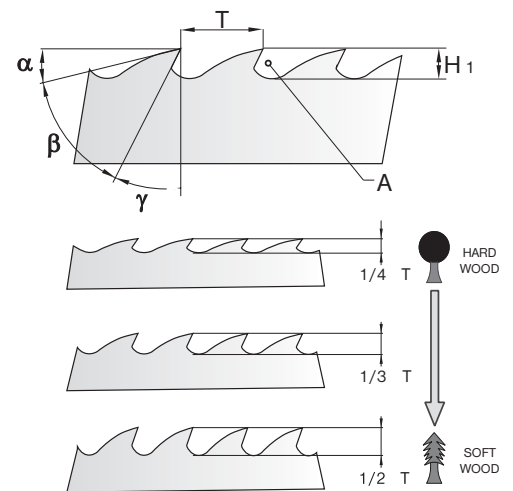

Most common problems	Probable reason	Solution
Tooth cracking	Allowance in bearings of wheels	Adjust the allowance, change bearings
	Dirt between wheel and blade	Clean the wheels, service regularly
	Long cutting process without break	Use blades max. 2hours / leave resting for 24hours then
	Too long grinding	Grind very smoothly, wet grind, surface roughness max. $Ra < 3,2$
	Blade is dull	Sharpen, measure
Tooth breaking off	Hook angle is too big	Lower the hook angle
	Tooth setting is too big	Lower the tooth setting
Uneven cutting	Small hook angle	Make bigger hook angle
	Wrong choice of tooth pitch	Choose the right tooth pitch
	Bad condition of straightening device	Check the machine by expert / fix
	Asymmetrical setting/ press	Adjust the grinding machine

Machine Gang Saw Blades for Rip Cutting

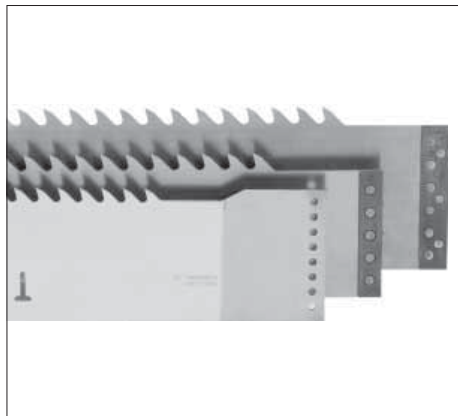

5360.1 (KV) – Wolf Type of Teeth 5360.01 (NV) – Triangular Type of Teeth

Application: For cutting soft and hard woods. While cutting with wolf teeth geometry you can reach more precise geometrical accuracy of cutting material. While cutting with triangular tooth geometry you can reach better surface quality – suitable for small diameter of logs.

Standard delivery: Machine gang saw blades are delivered in straightened and tensioned stage.

Side finish: Standard gang saw blades are delivered with hardened guide gibs of 35, 30, 25 mm width, with straight punching (Esterer hanges) and also blades without guide gibs.

KV

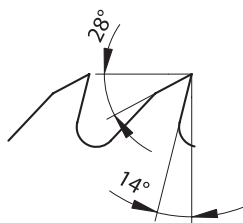

NV

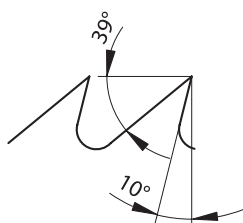

Dimensions of gang saws	Tooth pitch
140 x 1,8	22, 25, 26, 30
140 x 2,0	
140 x 2,2	
160 x 2,0	
160 x 2,2	
180 x 2,2	
180 x 2,4	

Gang saw blades are manufactured from material 75Cr1 (DIN 1.2003) with hardness 48 +/- 2Hrc. We can also produce gang saws coated with hard-chrome (surface of 10, 15 and 20microns). Hardchrome surface improves the resistance against tool wear. It is also resistant against high temperatures and protects against rust.

We are able to manufacture also other types of tothing (tooth pitch, shape) together with other types of guide gibs and pinholes on the request of our customers.

Machine Gang Saw Blades – Tempered

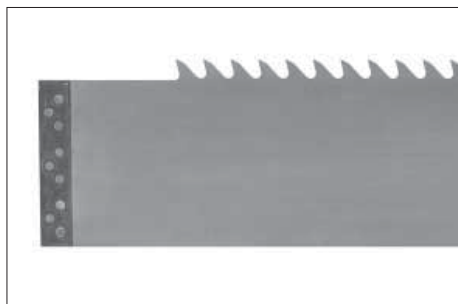

5362.1 (KV) – Wolf Type of Teeth

Application: For cutting hard and soft woods. Tempered gang saw is more efficient than the one with set teeth. Its advantage is a better stability of the tool, possibility to increase the feed speed and removing half size of chip when comparing with tooth set gang saw.

Standard delivery: Machine gang saw blades are delivered in straightened and tensioned stage.

Side finish: Standard gang saw blades are delivered with hardened guide gibs of 35, 30, 25 mm width, with straight punching (Esterer hanges) and also blades without guide gibs.

Dimensions of gang saws	Tooth pitch
140 x 2,2	22, 25, 26, 30
160 x 2,2	
180 x 2,2	

Gang saw blades are manufactured from material 75Cr1 (DIN 1.2003) with hardness 42 +/- 2Hrc. We are able to manufacture also other types of tothing (tooth pitch, shape) together with other types of guide gibs and pinholes on the request of our customers.

Machine Gang Saw Blades Stellite – Tipped

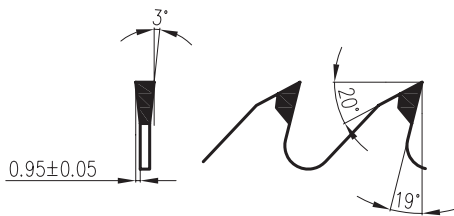

5366.1 (KV) – Wolf Type of Teeth

Application: Hard and soft woods. It is needed to know while ordering.

Standard delivery: Gang saw blades are delivered straightened and tensioned.

Side finish: Standard gang saw blades are delivered with hardened guide gibs of 35, 30, 25 mm width, with straight punching (Esterer hanges) and also blades without guide gibs.

Dimensions of gang saws	Tooth pitch
140 x 1,8	22, 25, 26, 30
140 x 2,0	
140 x 2,2	
160 x 2,0	
160 x 2,2	
180 x 2,2	
180 x 2,4	
180 x 2,4	

Gang saw blades are manufactured from material 75Cr1 (DIN 1.2003) with hardness 48 +/- 2Hrc. Welding and stellite grinding is performed on Vollmer machines.

Main Advantages of Stellite-Tipped Gang Saws:

1. Long life – time of tips (5 – 10 x more than normal version).
2. Lower energy intensiveness while cutting.
3. Lower tendency to tip damage due to dirt (compared TCT tools).
4. Higher surface quality of cutting material.
5. Higher dimensional and formal accuracy of cutting material.
6. Possibility to adjust tip geometry to particular cutting conditions (machine type, type of cutting material, cutting conditions etc.).
7. Due to higher cutting power enable lower thermal cutting stress of tip.
8. Possibility to re-tip the tool after grinding off the whole layer of previous welding (after 15 – 20 sharpening).
9. Minimizing the stand-time when changing the dull tools in machines.
10. Increasing the cutting performance by faster feed speed when tempered gang saws are replaced with stellite – tipped.

Gang saw blades are manufactured with tooth number and side finish according to our general types or to customer's requirements. We are able to manufacture also other types of tothing (tooth pitch, shape) together with other types of guide gibs and pinholes on the request of our customers.

We can provide service of all gang saw blades with tooth pitch 26 and 30 mm.

Usage:

Due to their perfect cutting capabilities, the J-type saw blades are suitable for all types of tothing

**Characteristics:**

These saw blades have a special offset on their upper side which reliably eliminates undesirable tension in the blades. This technical solution is patented and registered at the Industrial Property Office in the Czech Republic, Slovakia and Poland.

Using the J-type saw blade brings about the following advantages:

- » as far as the tensioning of the blades is concerned, the saws are maintenance free; it is only necessary to adjust potential humps
- » the price is the same as the price of an ordinary gang saw blade
- » due to the fact that no rolling traces are present, the material is not disrupted or reduced – therefore no breakage into the rolling trace may occur
- » it can be sharpened by basically all types of ordinary grinding machines
- » you can attach it to the standard hangs which you currently have
- » we supply it in any length from 1000 to 1600 mm, in widths and thicknesses identical to ordinary gang saw blades
- » they can be fitted with standard as well as atypical guide gibs, the pinholes (perforation) suitable for ESTERER hangs
- » hard-chrome coating, stellite-tipped teeth

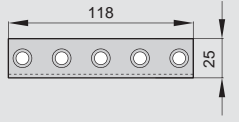
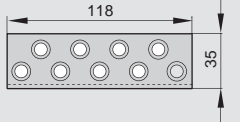
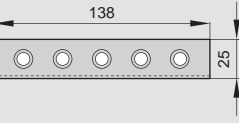
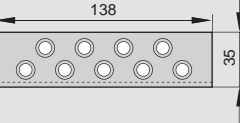
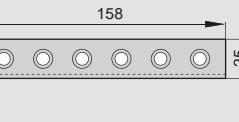
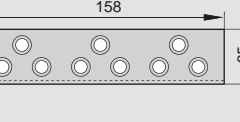
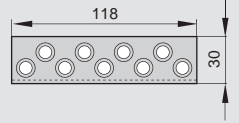
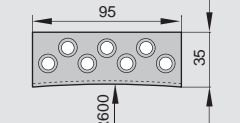
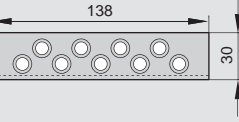
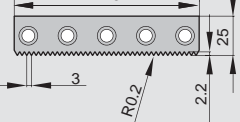
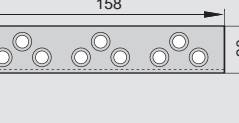
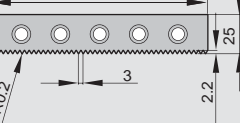
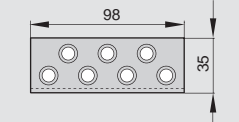
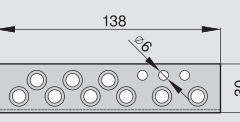
Type	Picture	Specifications	Type	Picture	Specifications
L118x25		Thickness: 2,9 mm Pinholes: 5 spacing 25 mm Bevel: 60° Hardness: 36±2 HRc Standard use for: gang saws of 140 mm width	L118x35		Thickness: 2,9 mm Pinholes: 9 spacing 25/25 mm Bevel: 60° Hardness: 36±2 HRc Standard use for: gang saws of 140 mm width
L138x25		Thickness: 2,9 mm Pinholes: 5 spacing 25 mm Bevel: 60° Hardness: 36±2 HRc Standard use for: gang saws of 160 mm width	L138x35		Thickness: 2,9 mm Pinholes: 9 spacing 25/25 mm Bevel: 60° Hardness: 36±2 HRc Standard use for: gang saws of 160 mm width
L158x25		Thickness: 2,9 mm Pinholes: 6 spacing 25 mm Bevel: 60° Hardness: 36±2 HRc Standard use for: gang saws of 180 mm width	L158x35		Thickness: 2,9 mm Pinholes: 9 spacing 25/50 mm Bevel: 60° Hardness: 36±2 HRc Standard use for: gang saws of 180 mm width
L118x30		Thickness: 2,9 mm Pinholes: 9 spacing 25/25 mm Bevel: 60° Hardness: 36±2 HRc Standard use for: gang saws of 140 mm width	L95x35 Lipowski		Thickness: 2,9 mm Pinholes: 7 spacing 25/25 mm Bevel: 60°, radius R~600 Hardness: 36±2 HRc Standard use for: Various types
L138x30		Thickness: 2,9 mm Pinholes: 9 spacing 25/25 mm Bevel: 60° Hardness: 36±2 HRc Standard use for: gang saws of 160 mm width	L118x25 OZUB T3		Thickness: 2,9 mm Pinholes: 5 spacing 25 mm Bevel: No, tothing type 3 Hardness: 36±2 HRc Standard use for: gang saws of 140 mm width
L158x30		Thickness: 2,9 mm Pinholes: 9 spacing 25/50 mm Bevel: 60° Hardness: 36±2 HRc Standard use for: gang saws of 180 mm width	L138x25 OZUB T3		Thickness: 2,9 mm Pinholes: 5 spacing 25 mm Bevel: No, tothing type 3 Hardness: 36±2 HRc Standard use for: gang saws of 160 mm width
L98x35		Thickness: 2,9 mm Pinholes: 7 spacing 25/25 mm Bevel: 60° Hardness: 36±2 HRc Standard use for: gang saws of 120 mm width	L138x30 3xOT6		Thickness: 2,9 mm Pinholes: 9 spacing 22/22 mm 3 + 13 mm Bevel: 60° Standard use for: gang saws of 160 mm width

Other types of fixing gib designs (atypical designs for extra charge)

- » gibs with no bevel
- » arched gibs (radius R~600 mm, different external dimension than the dimensions specified in the chart above)
- » gibs with tothing (different from the above specified)
- » divided gibs (gib is divided in an asymmetric or symmetric manner into 2 or more parts)

Saw blades with no gibs

- » with straight pinholes (perforation) suitable for the Esterer, Jansen, ASS hangs – holes of 8.3 diameter, spacing 17 millimetres
- » with atypical holes based on customer's specifications
- » gang saw blades with no perforation

Address

Nadrazni 804, Hulin
768 24, Czech Republic
Phone: +420 573 328 250, Fax: +420 573 328 141
E-mail: sales@pilana.cz www.pilana.com



Pilana
PILANA TOOLS

**Bandsaw blades
for wide
bandsaws**



Pilana
PILANA TOOLS

**Industrial
Knives**



Pilana
PILANA TOOLS

**Knives and Parts
for Panel Producers**
Cuchillas e partes
para fabricación
tableros



Pilana
PILANA TOOLS

**Profile Cutters Heads and
Profile Cutters and Planing
Knives**
Universalprofilfräskopf,
Hobelkopf, Profilmesser und
Hobelmesser
Frézovací a hoblovací hlavy,
blankety a profilové nože



Pilana
PILANA TOOLS

**Pily na řezání kovů
Metal cutting saws
Металлорежущие станки**



Pilana
PILANA TOOLS

**Metal
cutting tools**

www.pilana.cz



Pilana
PILANA TOOLS

**Steel
Centres**



Pilana
PILANA TOOLS

**Hand
tools**



Contact:
PILANA TOOLS a.s.
Nadrazni 804
768 24 Hulín
CZECH REPUBLIC
Phone: +420 573 328 250
Fax: +420 573 328 141
E-mail: sales@pilana.cz
www.pilana.com

